

LS-123456

**FR** Lire attentivement le livret consignes de sécurité et ce livret avant la première utilisation. / **EN** Read safety instructions and booklet carefully before using for the first time. / **DE** Lesen Sie vor der ersten Benutzung die Sicherheitshinweise und die Broschüre sorgfältig durch. / **NL** Neem vóór het eerste gebruik dit boekje en het boekje met de veiligheidsvoorschriften aandachtig door. / **IT** Leggere con attenzione il libretto sulle norme di sicurezza e questo libretto, al primo utilizzo. / **ES** Lea detenidamente las instrucciones de seguridad y este folleto antes de utilizar el aparato por primera vez. / **PT** Leia atentamente as instruções de segurança bem como este folheto antes da primeira utilização. / **EL** Διαβάστε προσεκτικά το φυλλάδιο με τις οδηγίες ασφαλείας καθώς και αυτό το φυλλάδιο πριν χρησιμοποιήσετε τη συσκευή για πρώτη φορά. / **DA** Læs hæftet med sikkerhedsanvisninger og dette hæfte omhyggeligt, inden apparatet tages i brug første gang. / **SV** Läs häftet med säkerhetsinstruktioner och det här häftet noga innan du använder apparaten första gången. / **FI** Lue turvallisuuohjekirjanen ja tämä kirjanen huolellisesti ennen ensimmäistä käyttökertaa. / **NO** Les nøye heftet med sikkerhetsinstruksjoner og dette heftet før første gangs bruk. / **TR** İlk kullanımdan önce güvenlik talimatlarını ve kitapçığı dikkatlice okuyunuz. / **RU** Перед первым использованием прибора внимательно ознакомьтесь с правилами техники безопасности и данной инструкцией. / **UK** Прочитайте інструкції з техніки безпеки і цю брошуру першим використанням приладу. / **KK** Бірінші рет қолданар алдында қауіпсіздік жөніндегі ережелер мен осы нұсқаулықты мұқият оқып шығыңыз. / **RO** Citiți cu atenție manualul cu instrucțiunile de siguranță și această broșură înainte de prima utilizare. / **SL** Pred prvo uporabo natančno preberite navodila za varno uporabo in ta navodila. / **SR** Pre prve upotrebe pažljivo pročitajte knjižicu s bezbednosnim uputstvima i ovu knjižicu. / **HR** Molimo da prije prve uporabe pažljivo pročitate sigurnosne upute i upute za uporabu. / **BS** Prije prve upotrebe pročitate knjižicu sa sigurnosna uputstva i knjižicu o upotrebi. / **BG** Прочетете внимателно книжката и съветете за безопасност в нея преди първата употреба. / **ET** Lugege enne esimest kasutuskorda tähelepanelikult ohutusnõudeid ja seda brošüüri. / **LV** Pirms pirmās lietošanas uzmanīgi izlasiet drošības norādījumus un šo informāciju. / **LT** Prieš naudodami prietaisą pirmą kartą įdėmiai perskaitykite saugos instrukciją ir šią instrukciją. / **PL** Przed pierwszym korzystaniem z urządzenia przeczytaj uważnie książkę z zasadami bezpieczeństwa oraz niniejszą instrukcję. / **CS** Před prvním použitím si pozorně přečtěte brožuru s bezpečnostními pokyny a tuto brožuru. / **SK** Pred prvým použitím si pozorne prečítajte brožúru „Bezpečnostné odporúčania a použitie“. / **HU** Az első használat előtt figyelmesen olvassa el a biztonsági előírásokat és a jelen brosúrát. / **TH** อ่านคำแนะนำเพื่อความปลอดภัยและคู่มือการใช้งานอย่างละเอียดก่อนการใช้งานเป็นครั้งแรก / **KO** 처음 사용 전 안전 지침과 현 책자를 잘 읽어 두시기 바랍니다. / **VI** VI: yọc s tay h ớng dãn an toàn v cu n s tay n y tr ớc khi sử dụng. / **ZH** 使用前，請仔細閱讀安全連繫手冊和說明書。 / **MS** Sila baca buku arahan keselamatan dan buku ini sebelum penggunaan untuk kali pertama. / **AR** قبل از استفاده دفترچه راهنمای ایمنی و این دفترچه را مطالعه کنید. / **FA** اقرار کتاب تعلیمات الامان بغنیایه قبل اول استخدام.

# Fresh Express

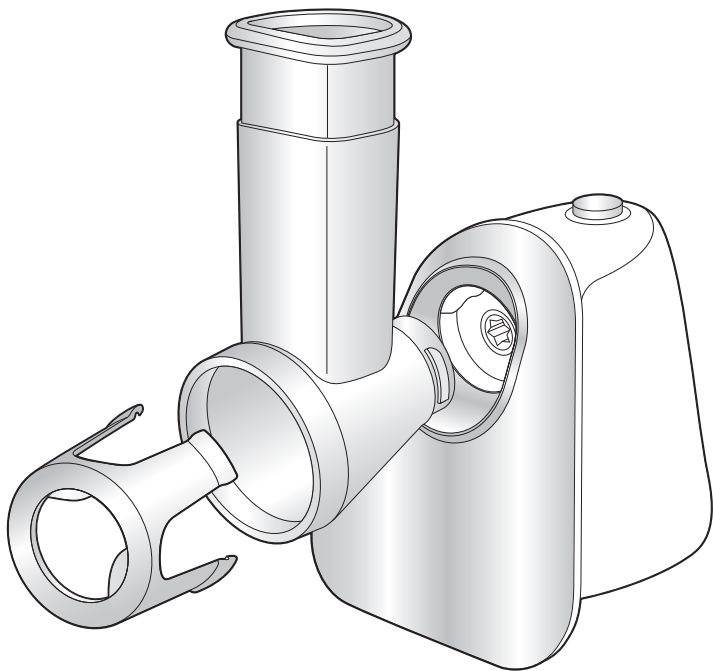

\*

*Selon modèle / Depending on model / Je nach Modell / Afhankelijk van het model / Secondo il modello/En función del modelo / Consoante o modelo/ανάλογα με το μοντέλο / Afhængig af model /Beroende på modell / Mallista riipruen/Avhengig av modell / Modele bağlı olarak/в зависимости от модели / залежно від моделі/үлгіге байланысты / În funcție de model/Glede na model / U zavisnosti od modela/Ovisno o modelu / Ovisno o modelu / В зависимости от модели/Söltuvalt mudelist / Atbilstoši modelim/Priklausomai nuo modelio / W zależności od modelu/Podle modelu / Podľa modelu/Modelltöl függően/แตกต่างกันไปในแต่ละรุ่น / 모델에 따라 다름 / Tùy theo mẫu / 視乎型號而定 : / Bergantung pada model / حسب النموذج / برحسب مدل*



E1a\*



E1b\*

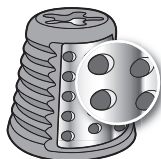

E2\*

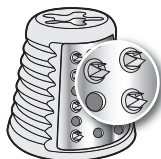

E3\*



E4\*

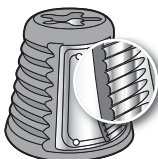

E5\*

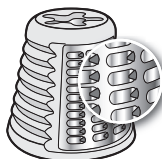

E6\*



E7\*

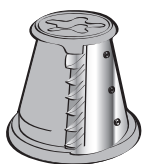

E8\*

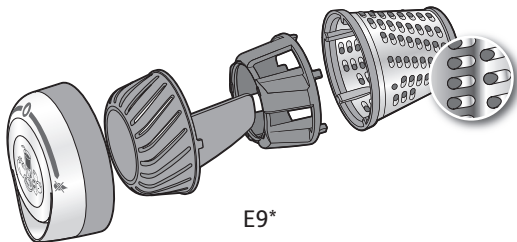

E9\*

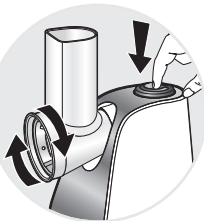
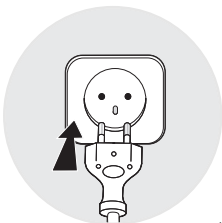
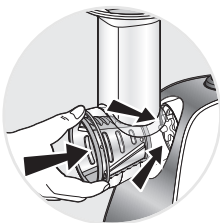
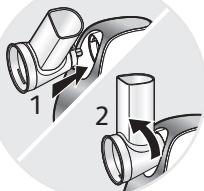
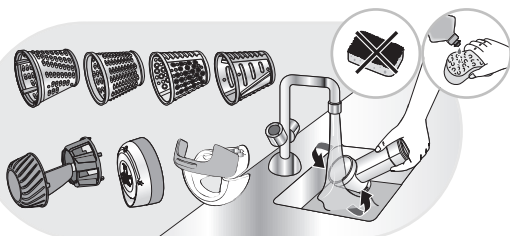

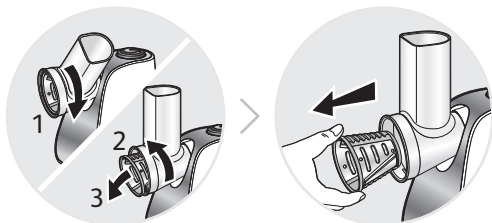

**E8\***





E9\*

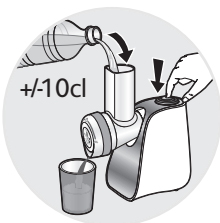
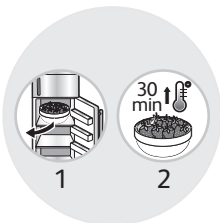
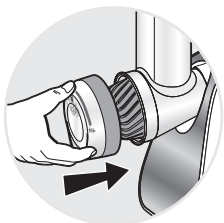
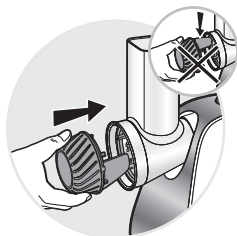
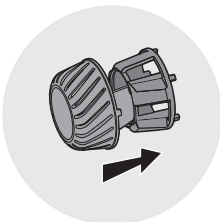
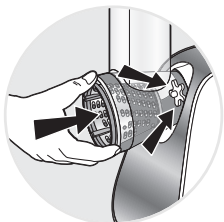





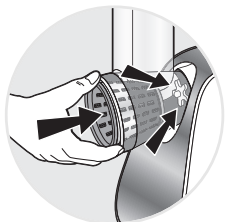

E7\*



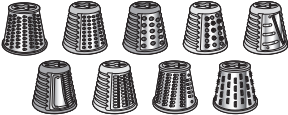
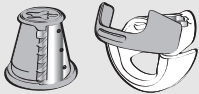
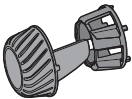

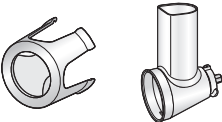
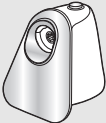
			
	✓	✓	✓
	✓	✓	✓
	✓	✓	✓
	✓	✗	✓
	✓	✓	✓
	✗	✗	✓





\*



\*



\*

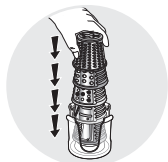

1



1

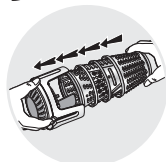

1

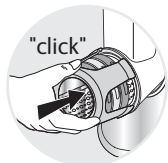

2



2



2

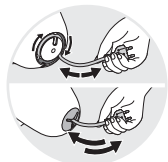

3

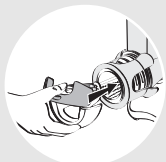

3

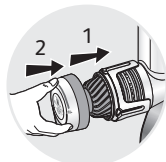

3



4



4



5





Процессоры электрические кухонные (мультирезки) Moulinex DJ75xxxx DJ76xxxx,  
DJ81xxxx

Изготовлено во Франции для холдинга "GROUPE SEB", France  
(Groupe SEB, Chemin du Petit Bois Les 4 M - BP 172 69134 Ecully Cedex France)  
Груп СЕБ, Шман дю Пти Буа Ле 4 М – БП 17269134 Экули Седекс Франс  
Официальный представитель, импортер - ЗАО "Группа СЕБ-Восток"  
125171, г. Москва, Ленинградское ш., д. 16А, стр. 3 тел. 213-32-32

Соответствуют требованиям:

- ТР ТС 004/2011 "О безопасности низковольтного оборудования", утв. Решением КТС от 16.08.2011г. №768.
- ТР ТС 020/2011 "Электромагнитная совместимость технических средств", утв. Решением КТС от 09.12.2011г. №879.

Срок службы изделия 2 года с даты продажи.

